

1

50001 + 50014 + 50936

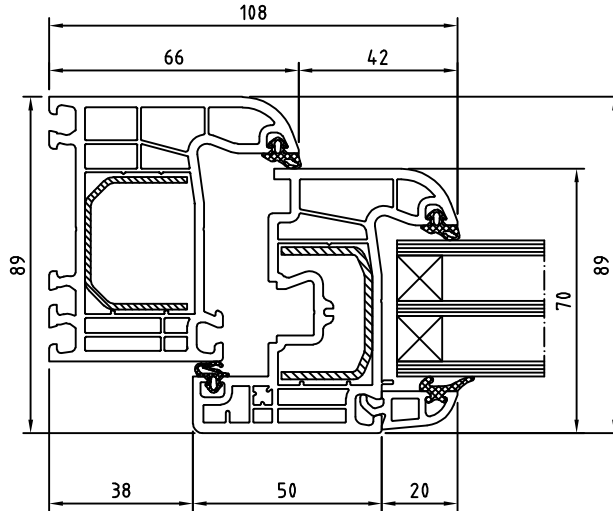
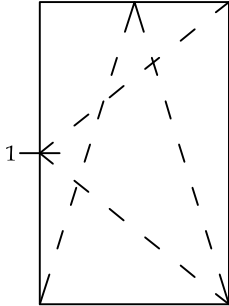

1

50003 + 50014 + 50936

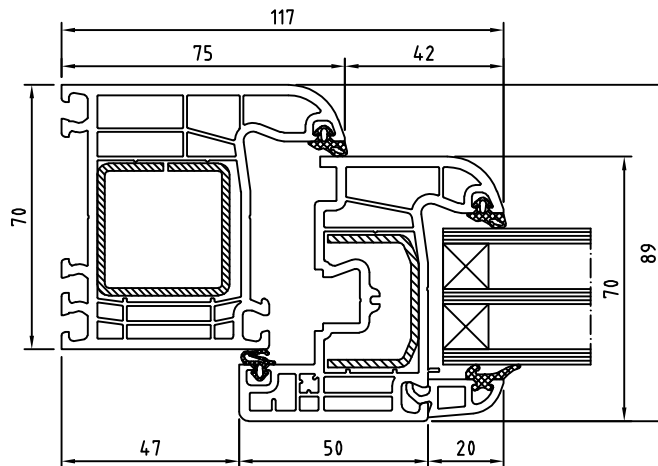

1

50004 + 50014 + 50936

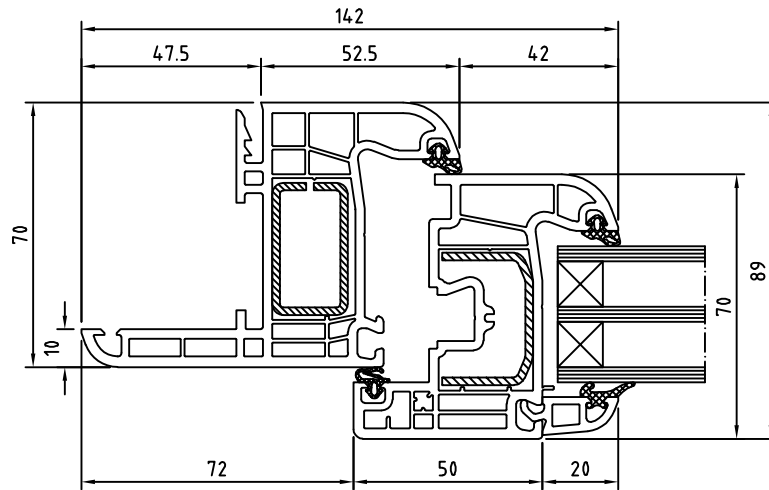
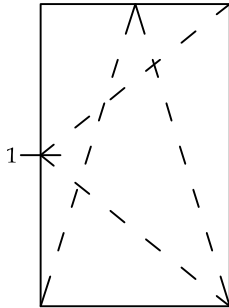

1

50005 + 50014 + 50936

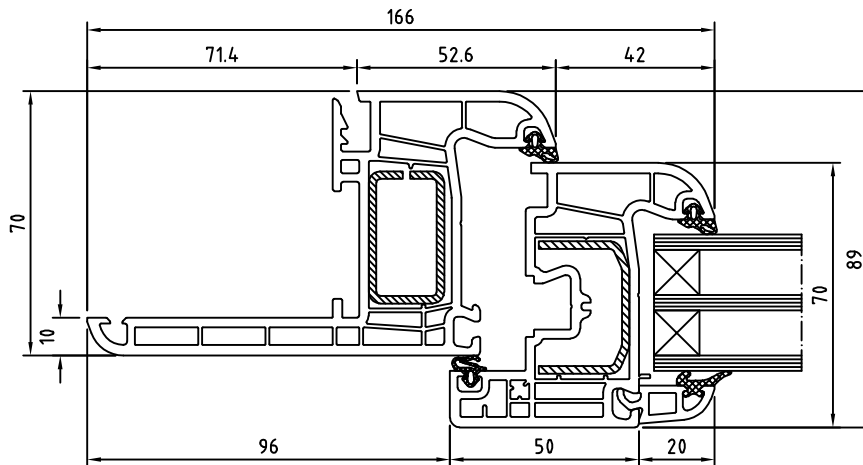

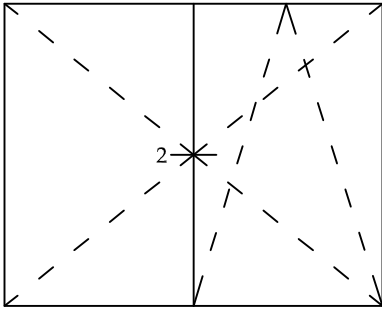

2

50936 + 50014 + 50021 + 50014 + 50936

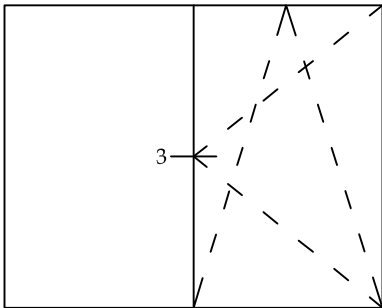
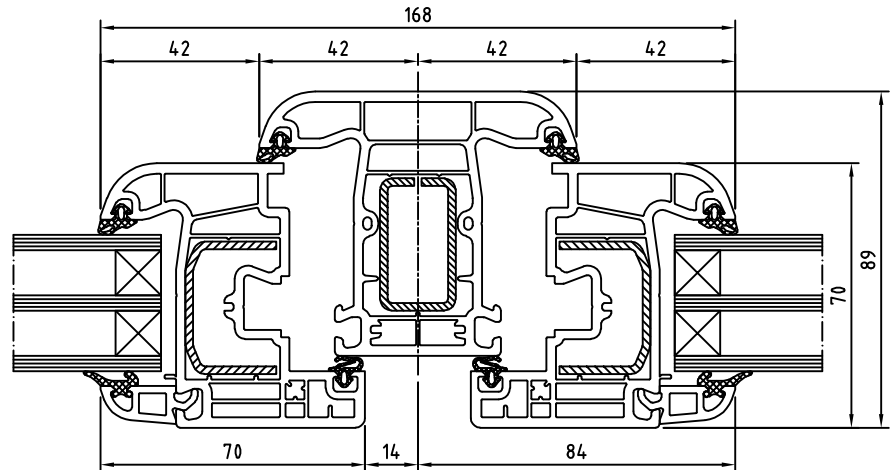

3

50936 + 50021 + 50014 + 50936

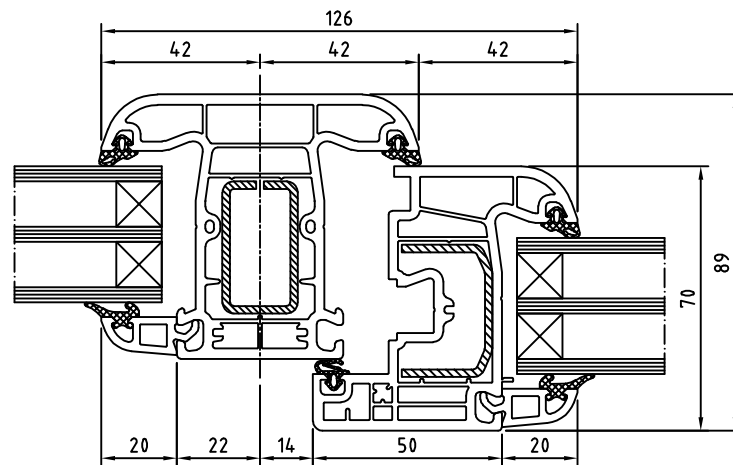

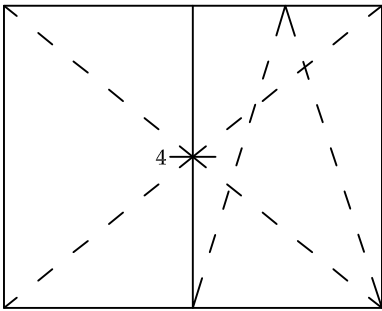

4

50936 + 50015 + (50027+50028) + 50014 + 50936

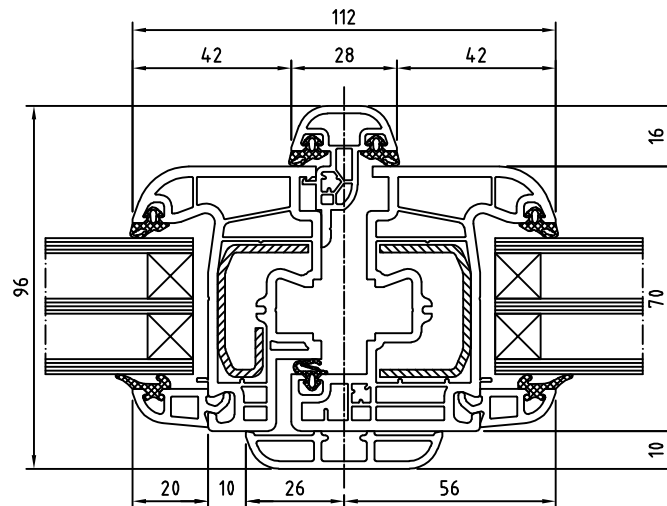

4

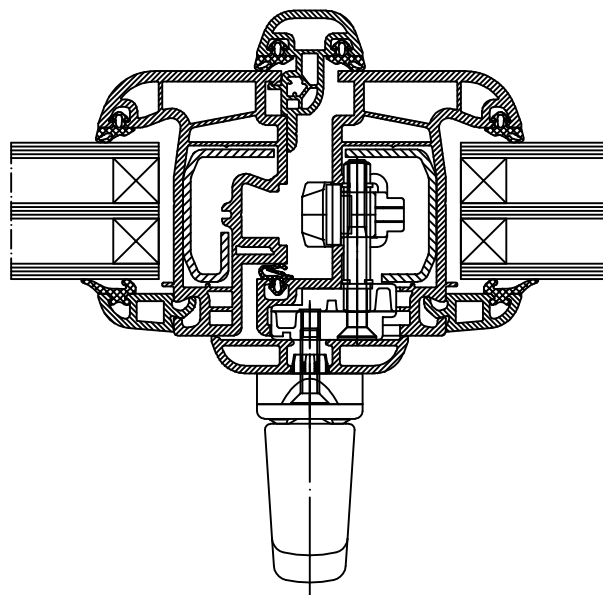

5

50003 + 50014 + 50936

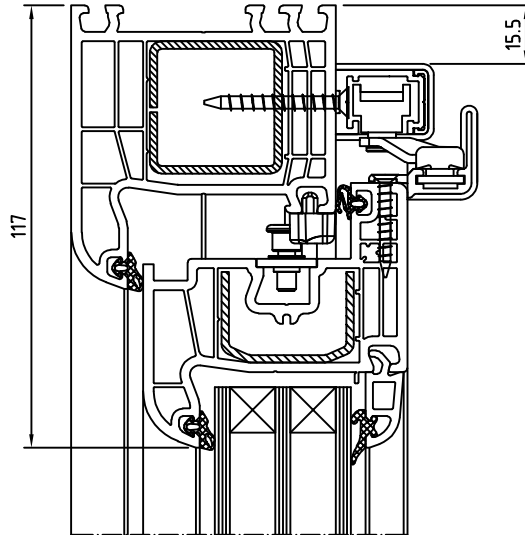
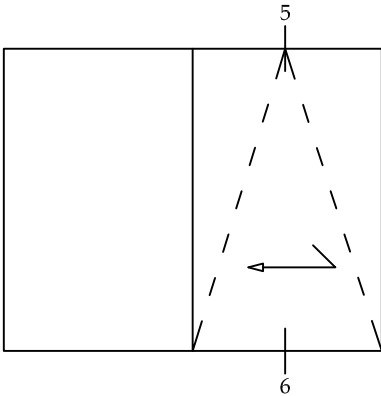

6

50003 + 50014 + 50936

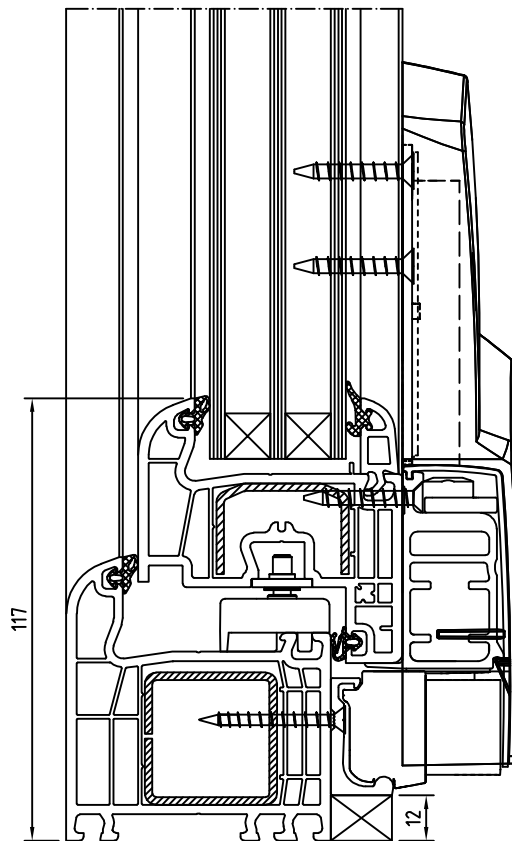

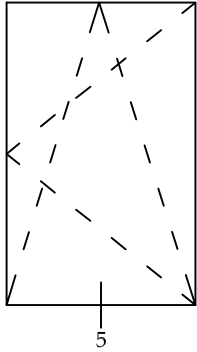

5

DKS 2.1.0 + 50014 + 50936

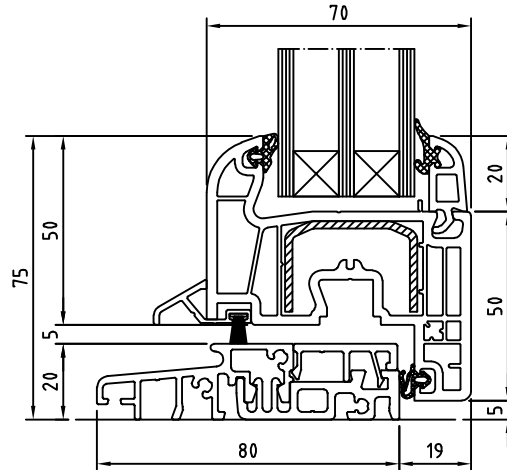

6

54123 + 50001 + 50014 + 50936

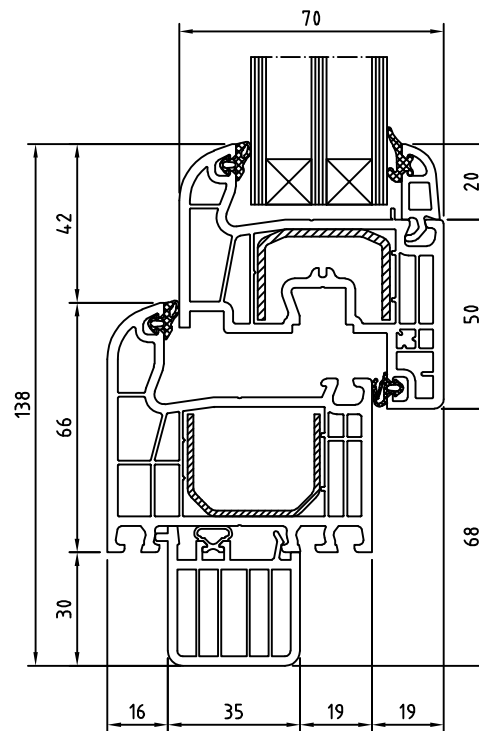
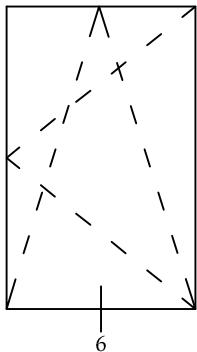

# IGLO Light

Przekroje  
Sections

Querschnitt  
Sezioni

